

CATALOGO DE INSUMOS Y HERRAMIENTAS



OSHWOOD
PROXIMIDAD

HERRAJES

CLIP PLASTICO

**CARACTERISTICAS:
PE, BLANCO, 10X30X8 mm**



TAPICERIA

NOSAG 3.6

CARACTERISTICAS:
Acero al alto carbono,
NEGRO, 3.6 mm

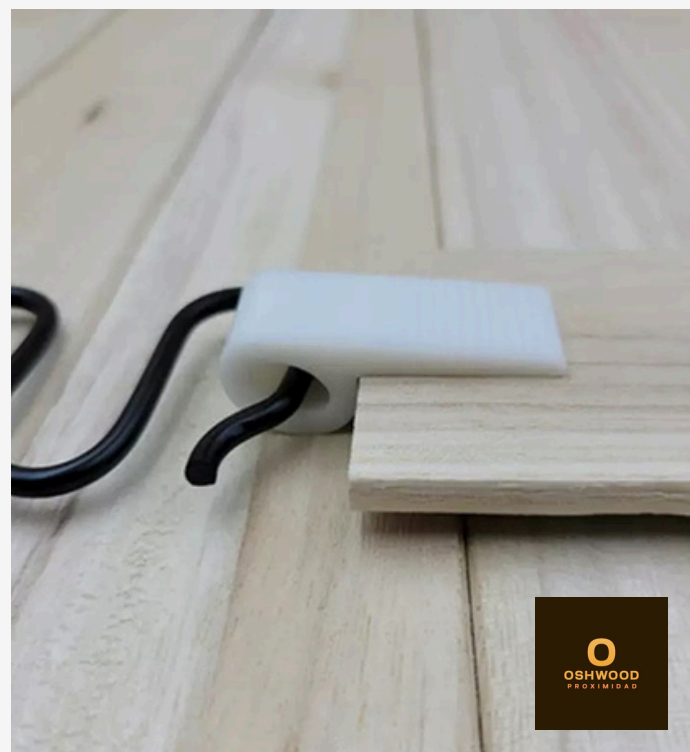

TAPICERIA

POCKET SPRING

CARACTERISTICAS:
40X50X7cm
45X50X7cm



HERRAMIENTA

CORTADORA DE NOSAG

CARACTERISTICAS:

Función: Corta y Dobla el nosag



HERRAJES

VARILLA DE FIJACION

CARACTERISTICAS:
Alambre recubierto de papel, 2 mm X 500 m



HERRAMIENTA

MEITE M66

CARACTERISTICAS:

Consumible: CL72

Ancho: 17 mm

Capacidad: 100 Grapas

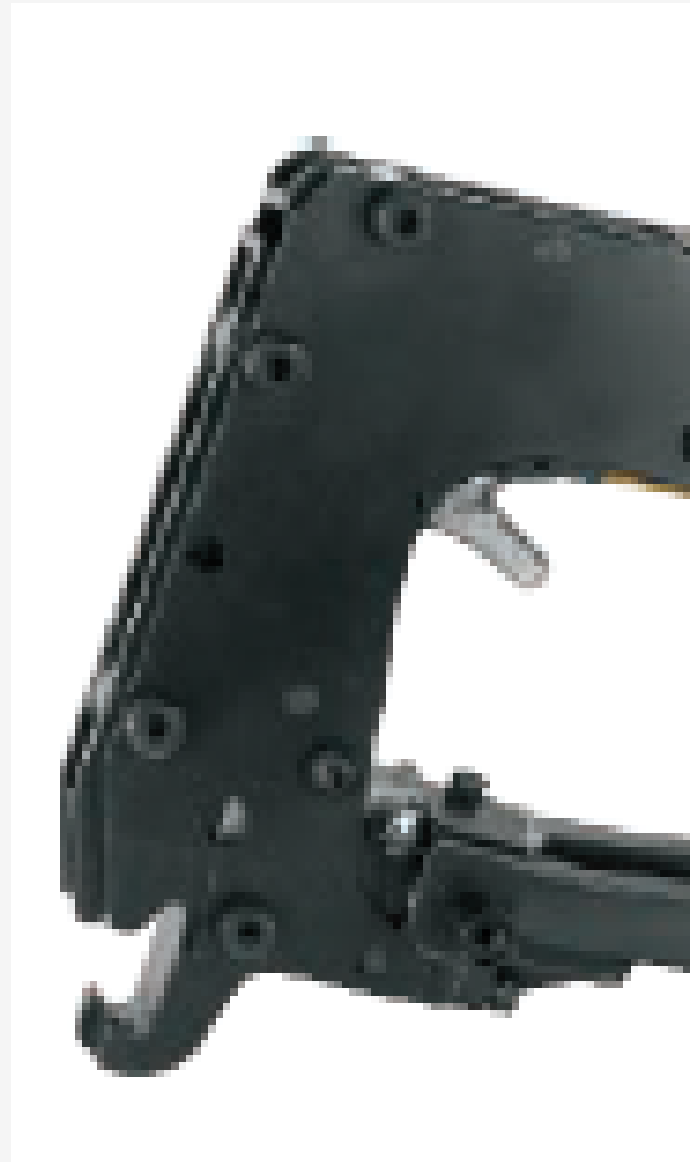

FIJACION

GRAPA CL72

CARACTERISTICAS:

Espesor: 6.5 mm

Ancho: 17 mm

Alto: 14 mm

Caja: 6000 Unidades



FIJACION

TIRA TACHUELA

CARACTERISTICAS:

Largo: 100 cm

Uso: Para tapiceria

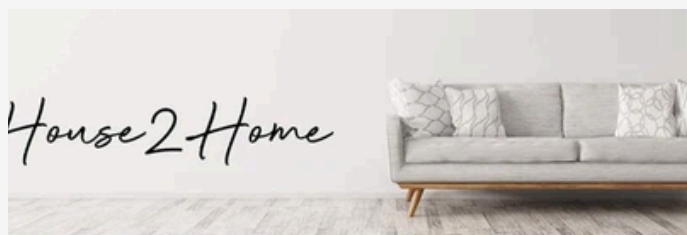
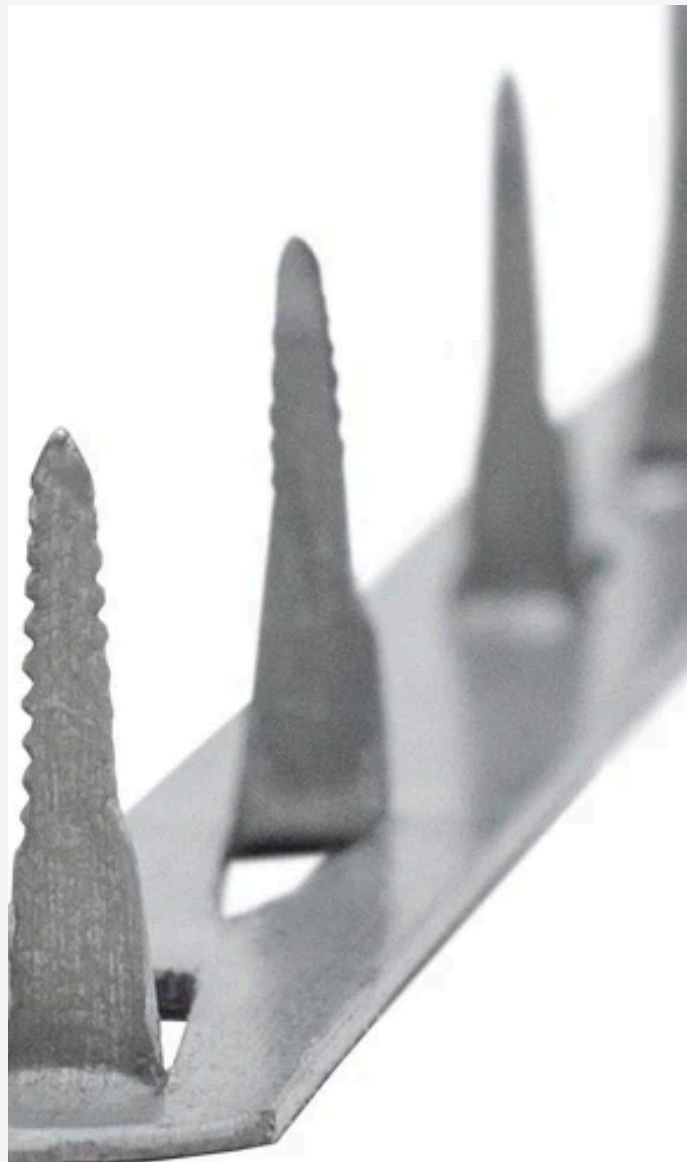

PACK



HERRAMIENTA

MEITE 7116B

CARACTERISTICAS:

Consumible: 7010

Largo del pico: 2 cm

Capacidad: 125 Grapas



HERRAMIENTA

MEITE 8116B

CARACTERISTICAS:

Consumible: 8010

Largo del pico: 2 cm

Capacidad: 125 Grapas



HERRAMIENTA

MEITE 7116

CARACTERISTICAS:

Consumible: 7010

Largo del pico: 2 cm

Capacidad: 150 Grapas



HERRAMIENTA

MEITE 8116

CARACTERISTICAS:

Consumible: 8010

Largo del pico: 2 cm

Capacidad: 150 Grapas



HERRAMIENTA

MEITE 7116LN

CARACTERISTICAS:

Consumible: 7010

Largo del pico: 5cm

Capacidad: 150 Grapas



HERRAMIENTA

MEITE 8116LN

CARACTERISTICAS:

Consumible: 8010

Largo del pico: 5cm

Capacidad: 150 Grapas



FIJACION

GRAPA 7110 8010

CARACTERISTICAS:
Grapa 7010 8010

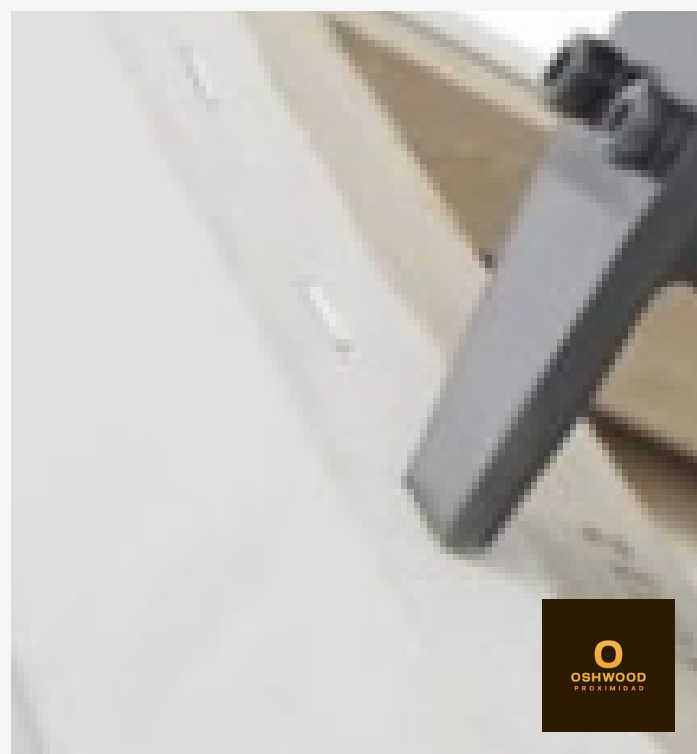
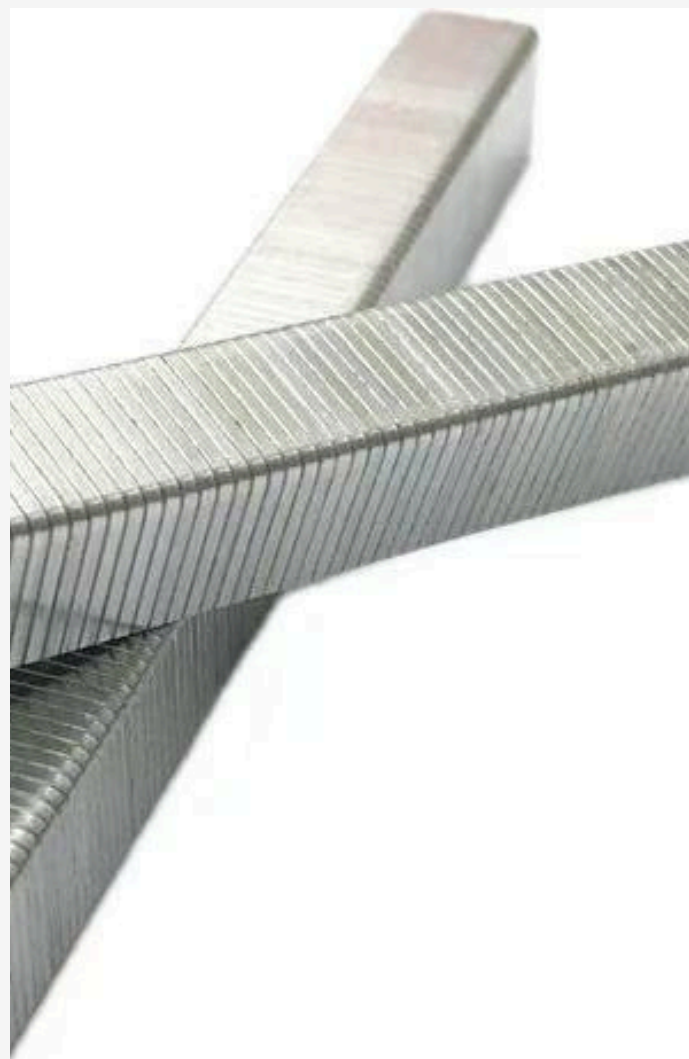
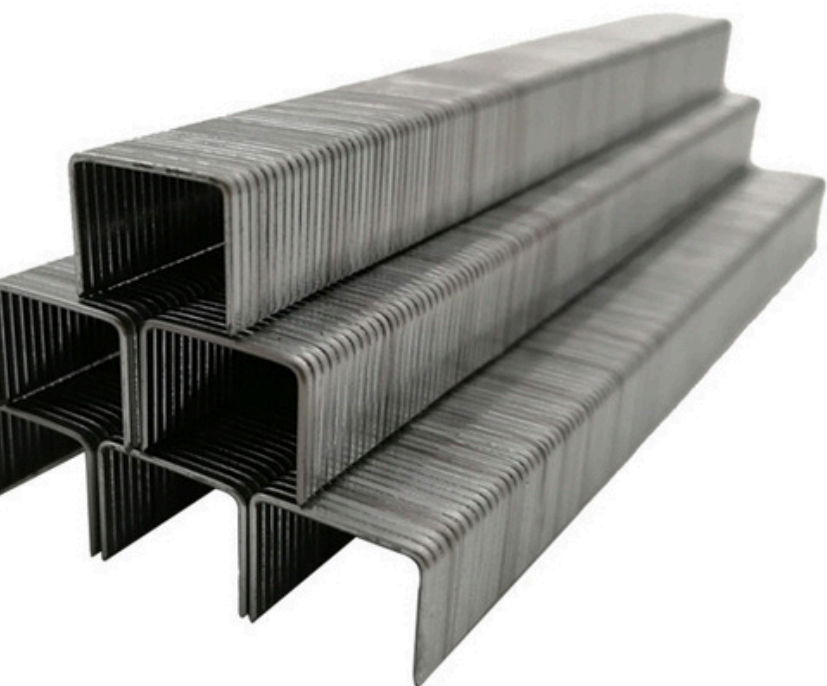

HERRAMIENTA

MEITE N851F

CARACTERISTICAS:

Consumible: N17

LEsqueletera

Capacidad: 140 Grapas

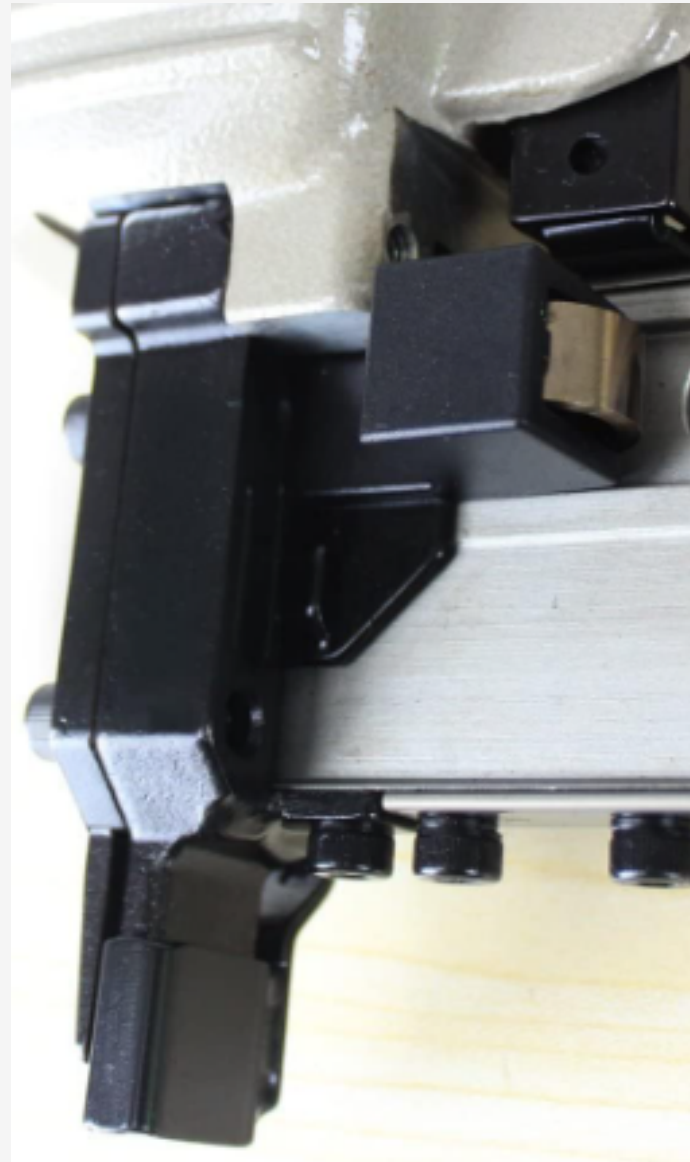

FIJACION

GRAPA ESQUELETERA

CARACTERISTICAS:
73X137
35 mm a 50mm

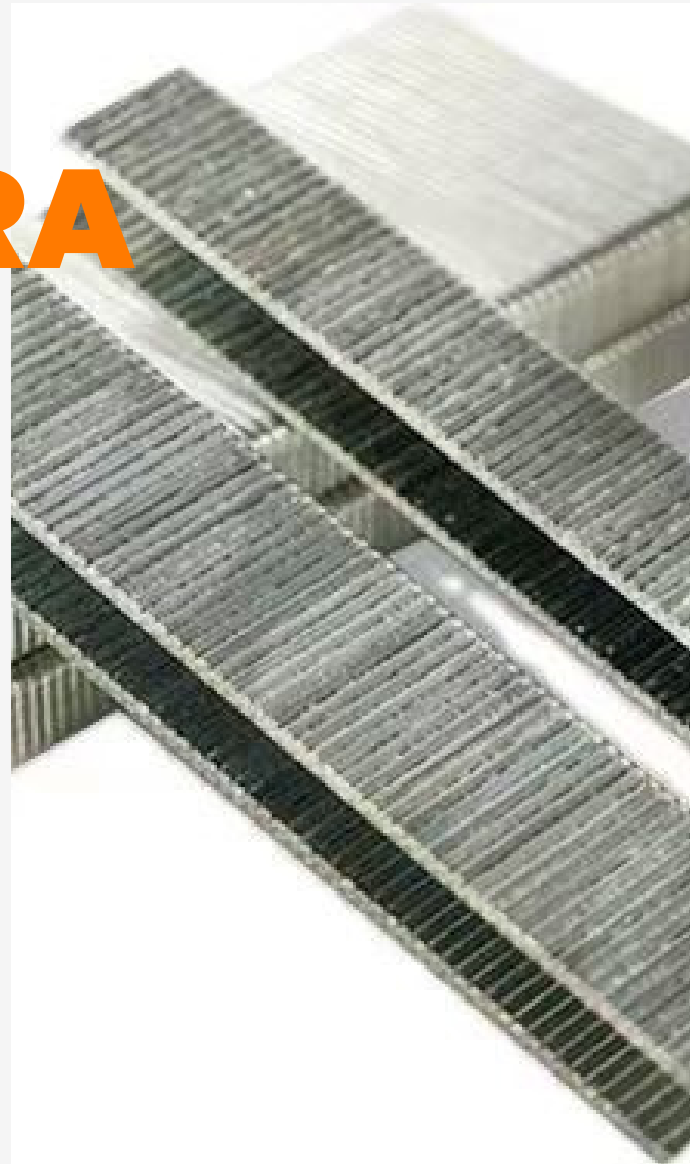
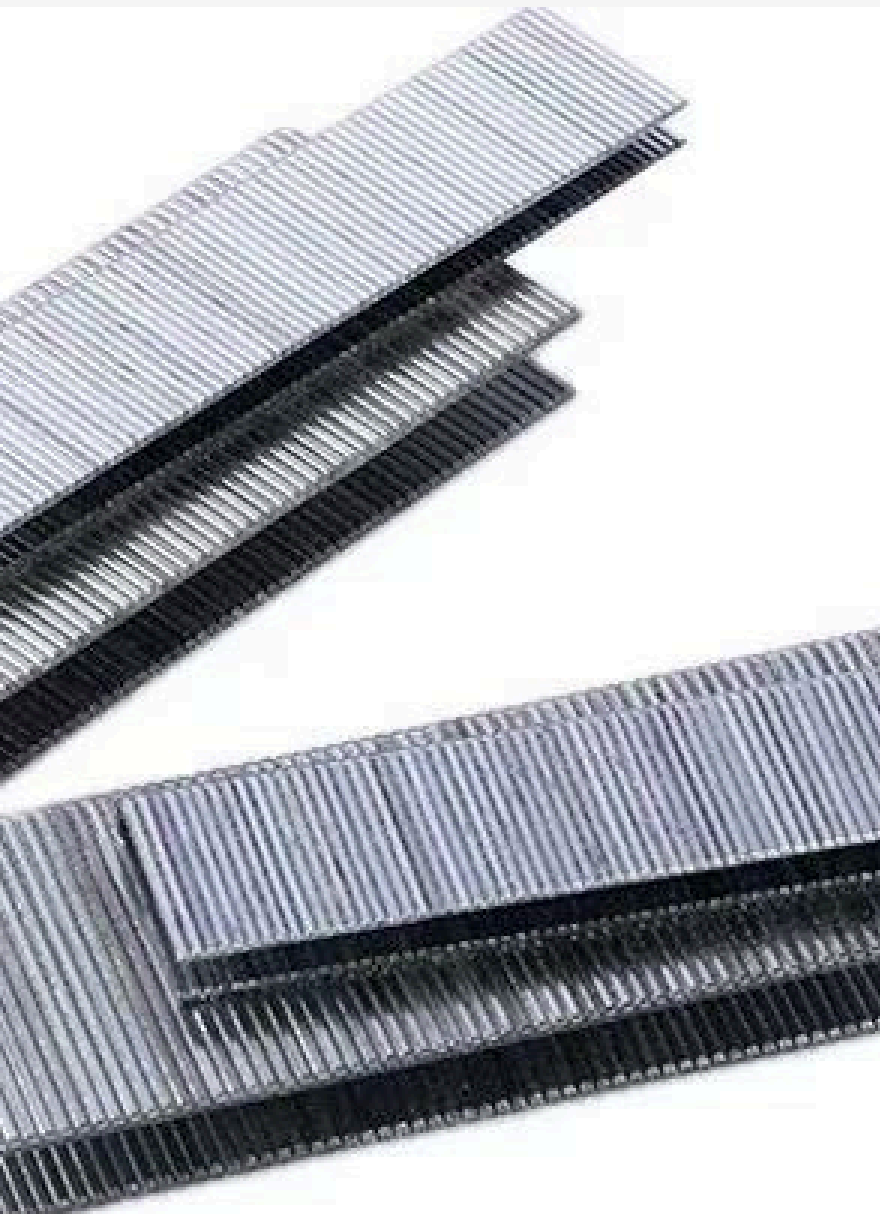

HERRAMIENTA

MEITE F50C

CARACTERISTICAS:
Consumible: Tipo F
Clavilladora
Capacidad: 140 Grapas

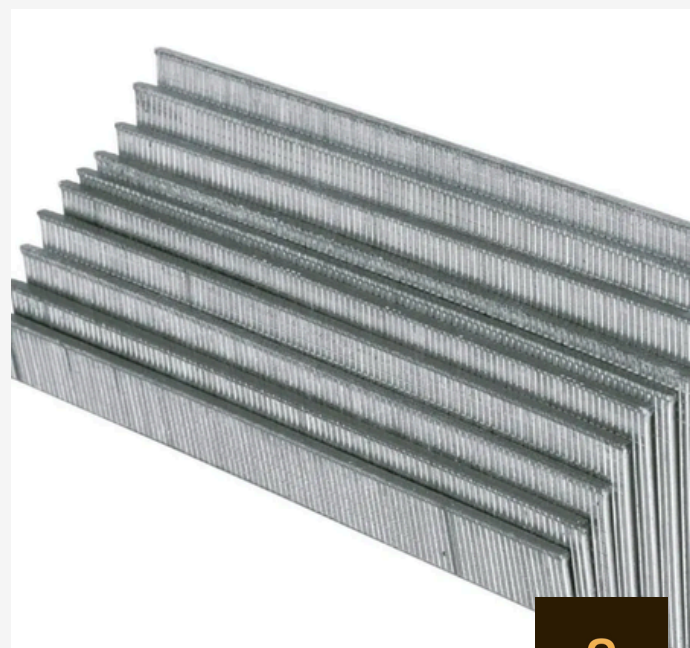

HERRAMIENTA

MEITE F50E

CARACTERISTICAS:
Consumible: Tipo F
Clavilladora
Capacidad: 140 Grapas

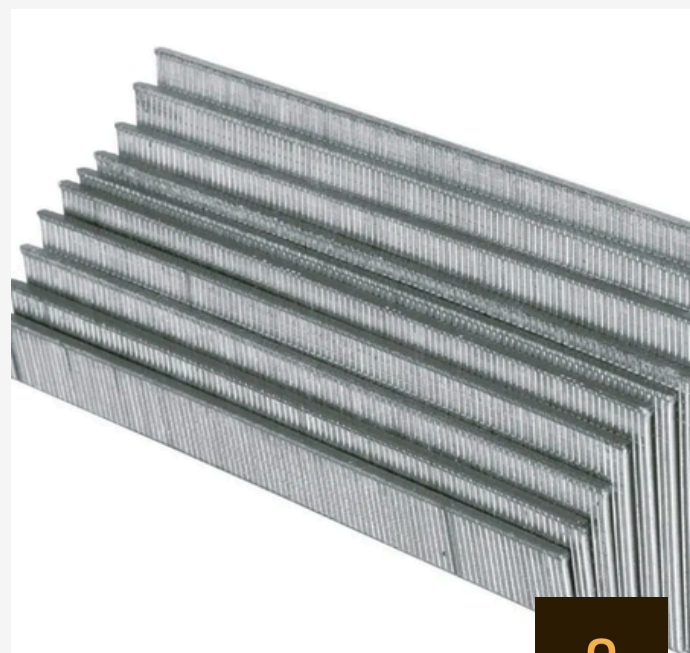

FIJACION

CLAVILLO TIPO F

CARACTERISTICAS:
Clavillo F19 F25 F39 F50

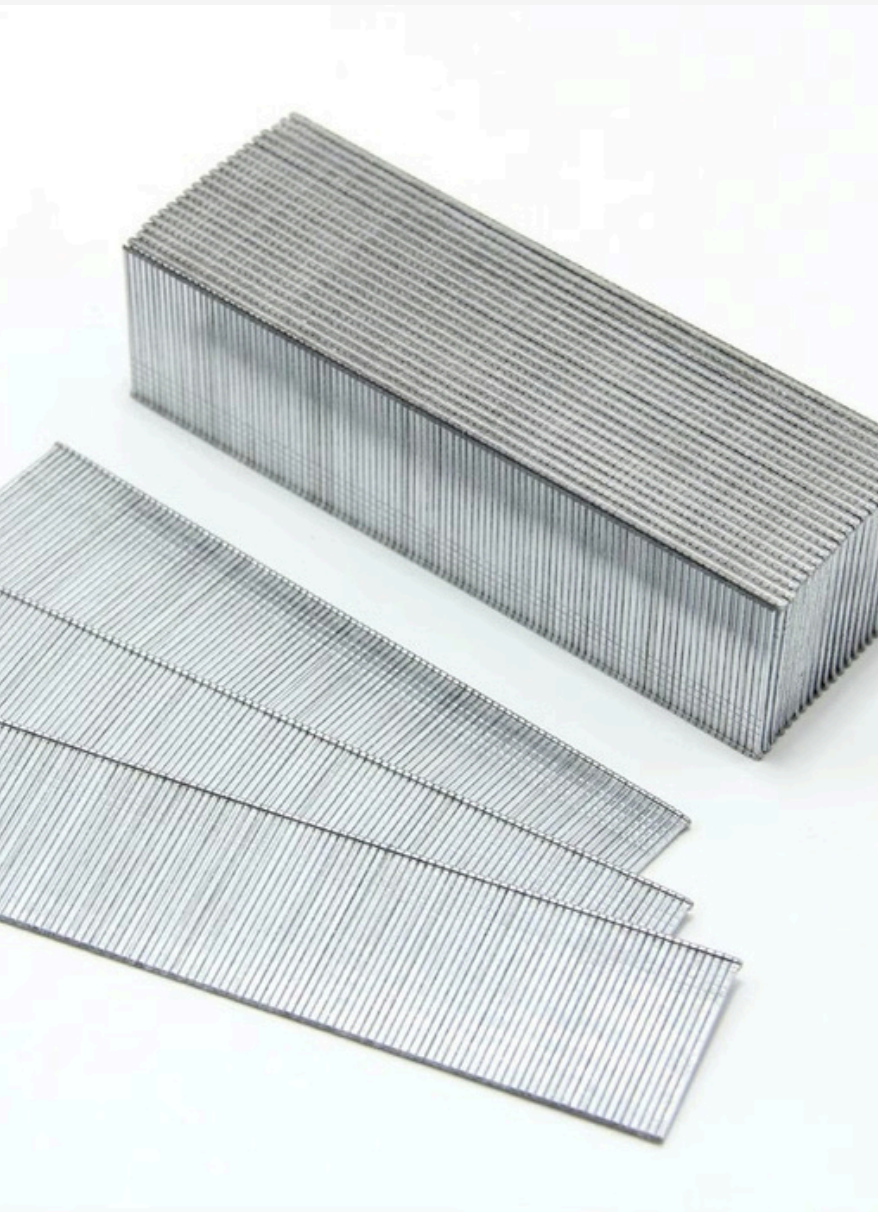

HERRAMIENTA

MEITE MP650B

CARACTERISTICAS:

**Consumible: Clavillo de
aguja**

Clavilladora

Capacidad: 140 Grapas

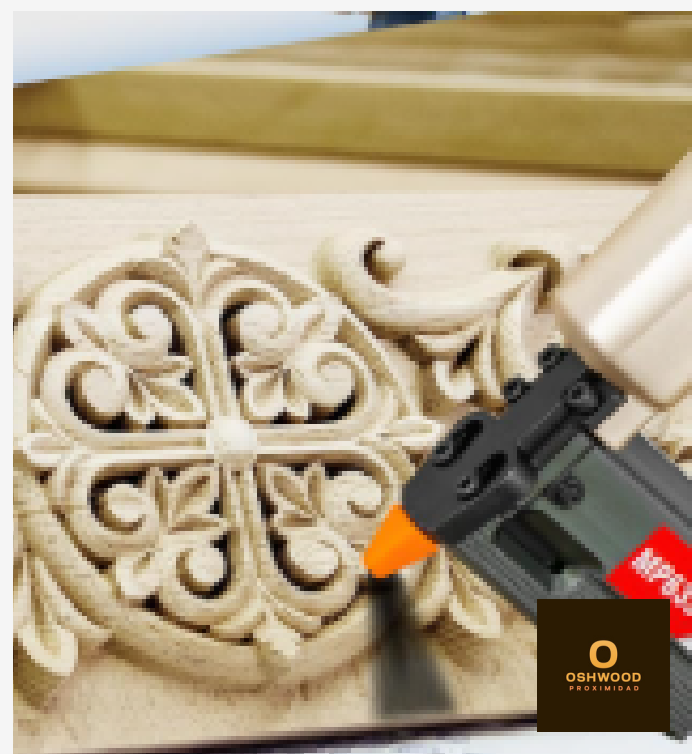

FIJACION

CLAVILLO DE AGUJA

CARACTERISTICAS:
Clavillo 19, 25, 50

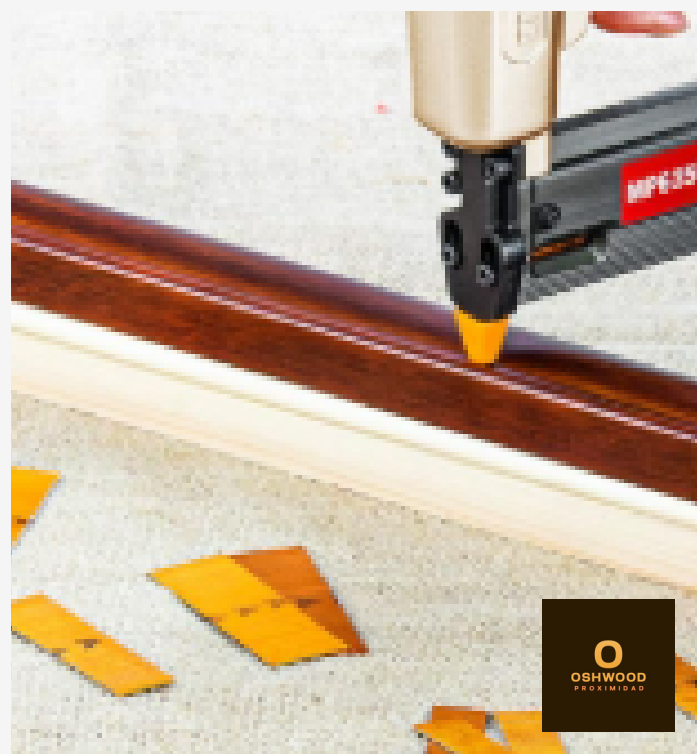
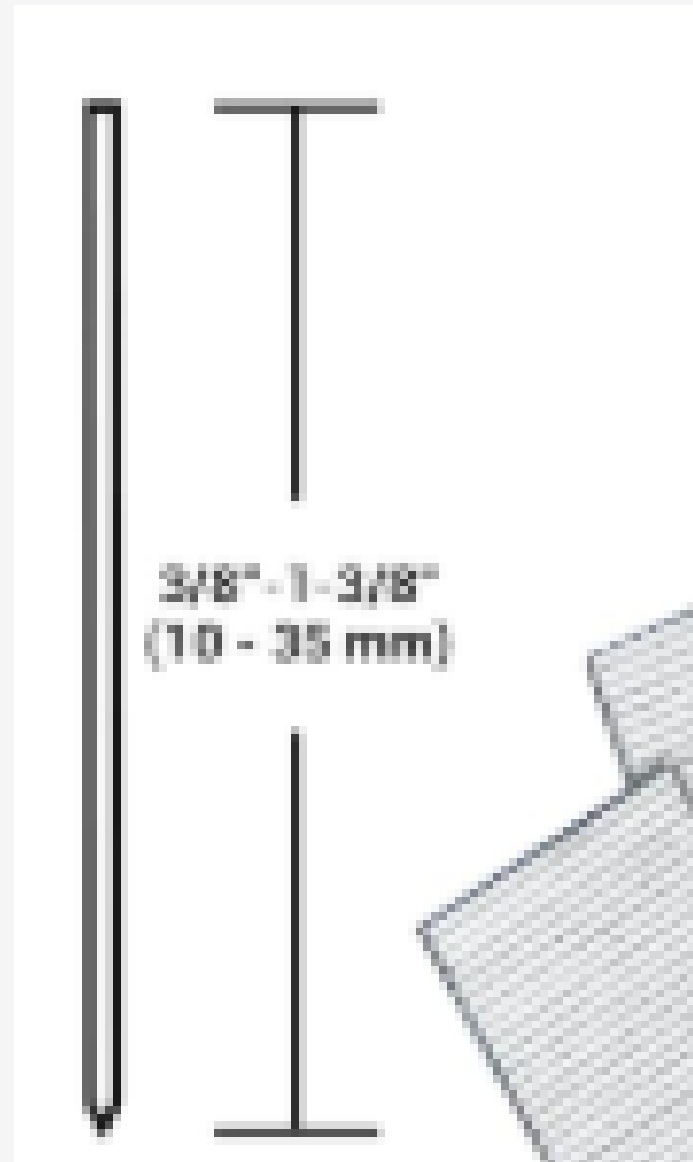

FIJACION

TUERCA BASE

CARACTERISTICAS:

M8

Diametro: 37 mm

Altura: 17 mm

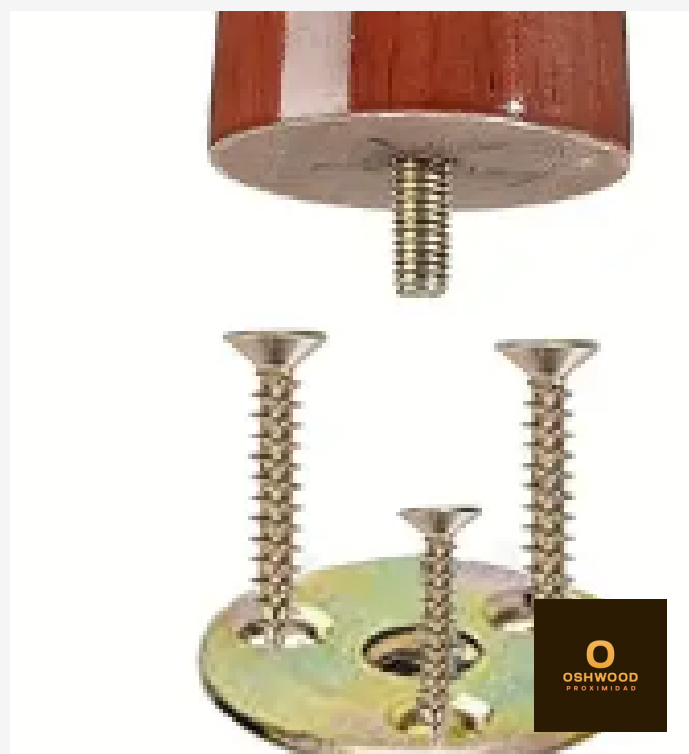

FIJACION

TUERCA INSERTO

**CARACTERISTICAS:
M6X10 M6X15 M6X20
M8X13 M8X17 M8X20
M8X25**



FIJACION

TORNILLO ALLEN BOLT

CARACTERISTICAS:
M8X25 M8X50 M8X60
M8X70
Color: Negro



FIJACION

TORNILLO ALLEN BOLT

CARACTERISTICAS:
M8X20 M8X25
Color: Niquelado



FIJACION

TORNILLO ALLEN

CARACTERISTICAS:
M6X25 M6X30 M6X40
M6X50 M8X50 M8X60
Color: Niquelado



FIJACION

LLAVE ALLEN

CARACTERISTICAS:
4 mm 5 mm 6 mm
Color: Cromado



FIJACION

ESPARRAGO DOBLE ROSCA

**CARACTERISTICAS:
M8X70 M8X80 M8X90
M8X100**

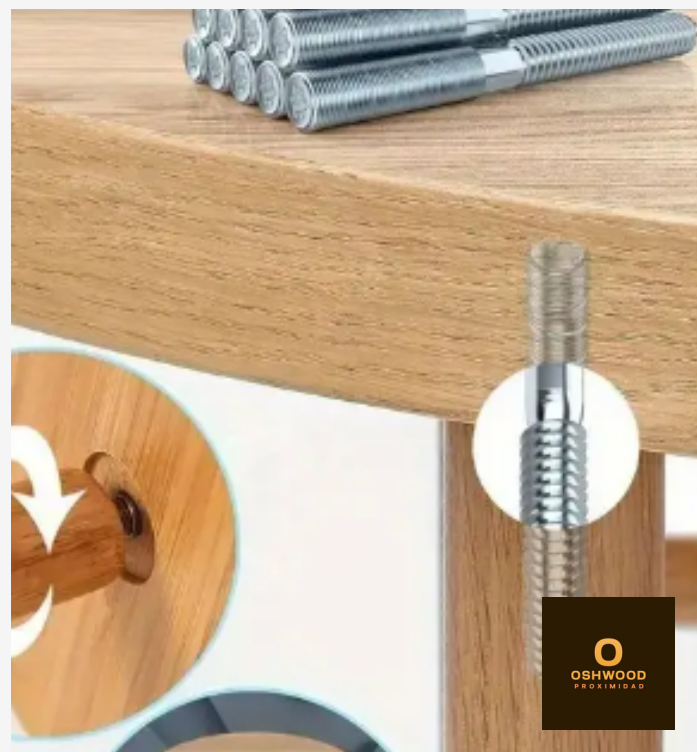

HERRAMIENTA

MEITE MT1206P

CARACTERISTICAS:
Taladro atornillador
neumatico



FIJACION

TORNILLO DRYWALL

CARACTERISTICAS:

#6 #8

1", 1 ½, 1 ¾, 2, 2 ½

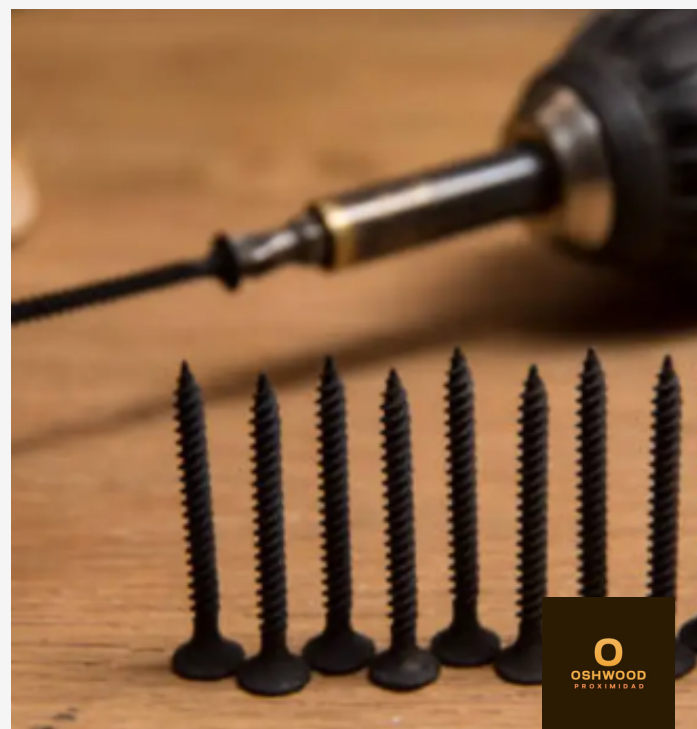

FIJACION

TARUGOS DE MADERA

CARACTERISTICAS:

Madera Pino seca

Medidas:

10 mm-12mmX40mm

10 mm-12mmX50mm

10 mm-12mmX60mm



HERRAMIENTA

MEITE MT5105

CARACTERISTICAS:
Lijadora neumática
orbital de 5 pulgadas



HERRAMIENTA

MEITE MT5106

CARACTERISTICAS:
Lijadora neumática
orbital de 6 pulgadas



HERRAMIENTA

MEITE MT10

CARACTERISTICAS:
Pistola de aire



HERRAMIENTA

MEITE CN70B

CARACTERISTICAS:
Clavadora Neumatica



Product Specifics

- Model Number: CN70B
- Suitable for Nails
- Length: 13.22" (336 mm)
- Width: 5.62" (143 mm)
- Weight: 3.84 KG / 8.47 LBS
- Capacity: 225 - 300
- Air inlet: 1/4" NPT
- Operating Pressure: 90 PSI

A versatile nail gun, adaptable to various scenarios



HERRAMIENTA

MEITE CN55

CARACTERISTICAS: Clavadora Neumatica

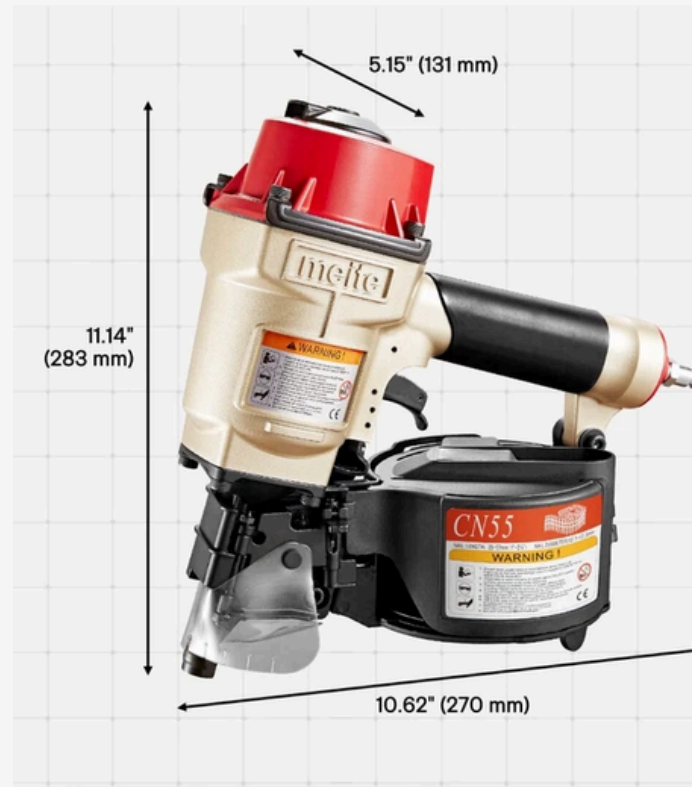

CN55 Specifications

Length: 10.62" / 270 mm

Width: 5.15" / 131 mm

Weight: 2.75 KG / 6.06 LBS

Capacity: 300 - 400 nails

Air Inlet: 1/4" NPT

Operating Pressure: 90 PSI



HERRAMIENTA

REPUESTOS MEITE

CARACTERISTICAS:
Para todas las
herramientas Meite



MT8016

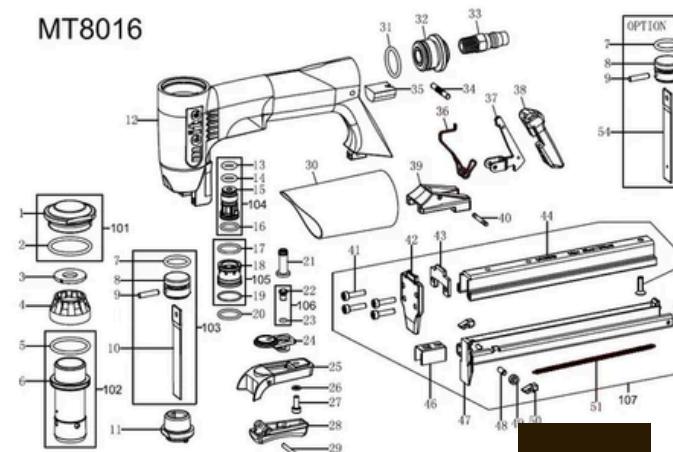

HERRAMIENTA

PISTOLA DE PINTURA

CARACTERISTICAS:
Pistola de pintura de alta
con boquilla de 2 mm



TAPICERIA

FELPA CIRCULAR

CARACTERISTICAS:

Espesor: 2.5 mm

Diametro: 20 mm

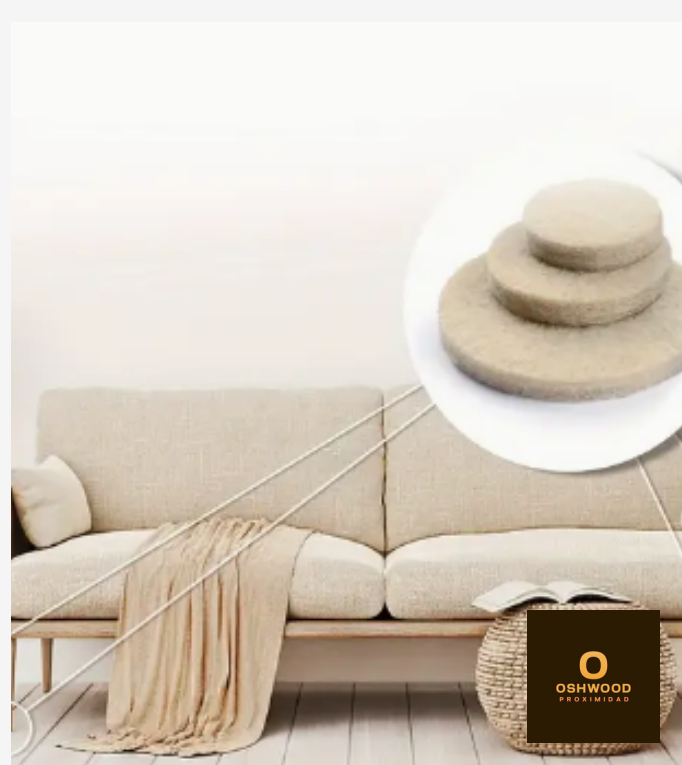

TAPICERIA

ROLLO DE FELPA

CARACTERISTICAS:

Espesor: 2.5 mm

Ancho: 25 mm

Largo: 10 m

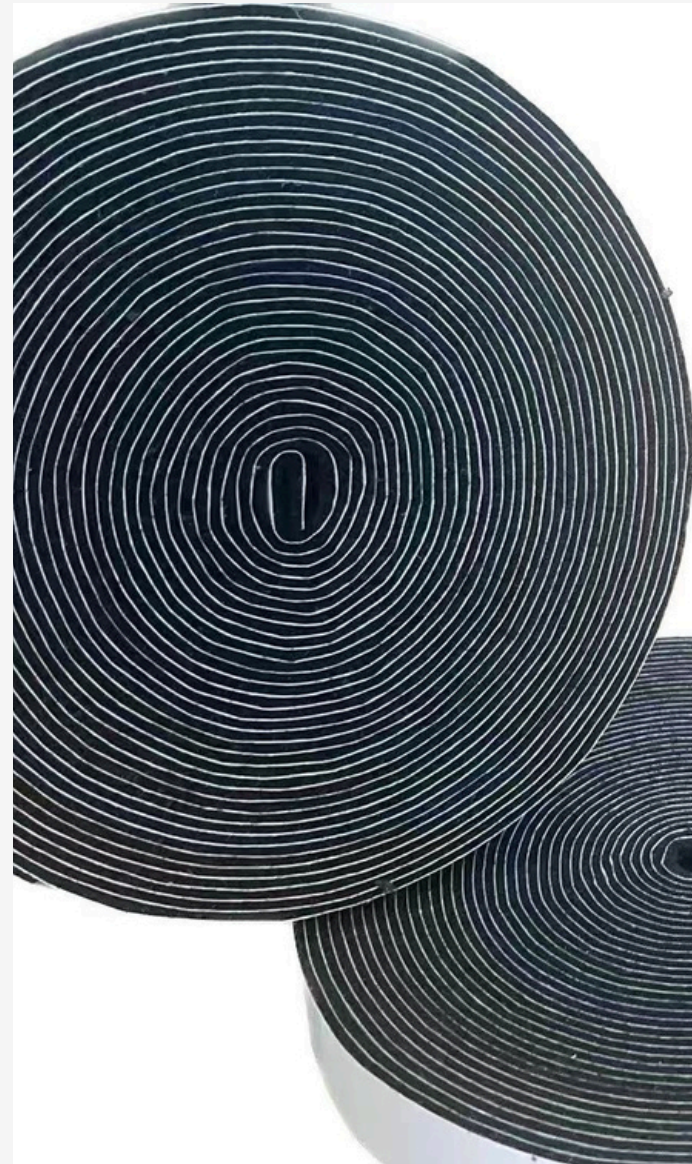

TAPICERIA

CINCHA ELASTICA

CARACTERISTICAS:

Ancho: 50 mm

Largo: 50 m

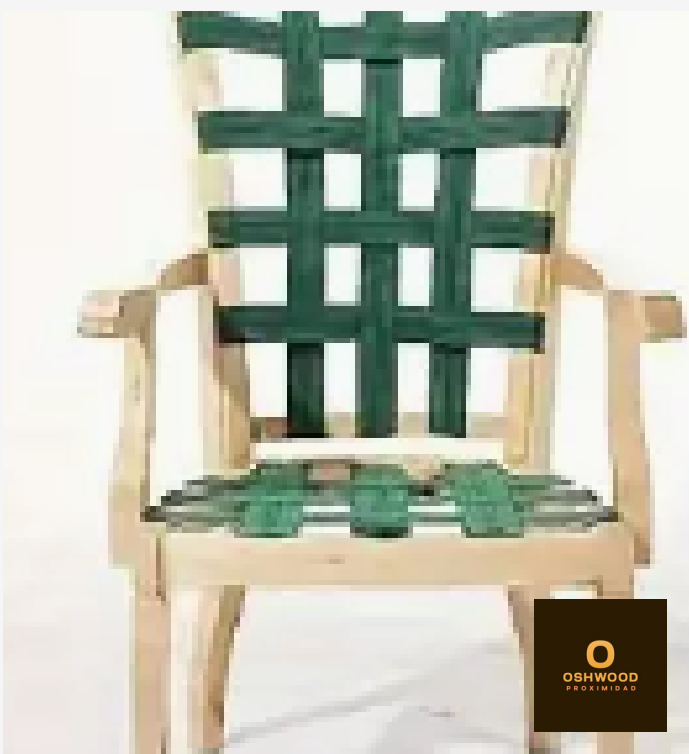

HERRAJES

CONECTOR INCLINADO

CARACTERISTICAS:
Diametro central: M8
48X48



HERRAJES

CONECTOR DE SOFA

CARACTERISTICAS:
8X6.5



HERRAJES

CONECTOR DE SOFA

CARACTERISTICAS:
17.5



TAPICERIA

VELCRO

CARACTERISTICAS:

Color: Negro

Ancho: 20 mm

Largo: 25 metros

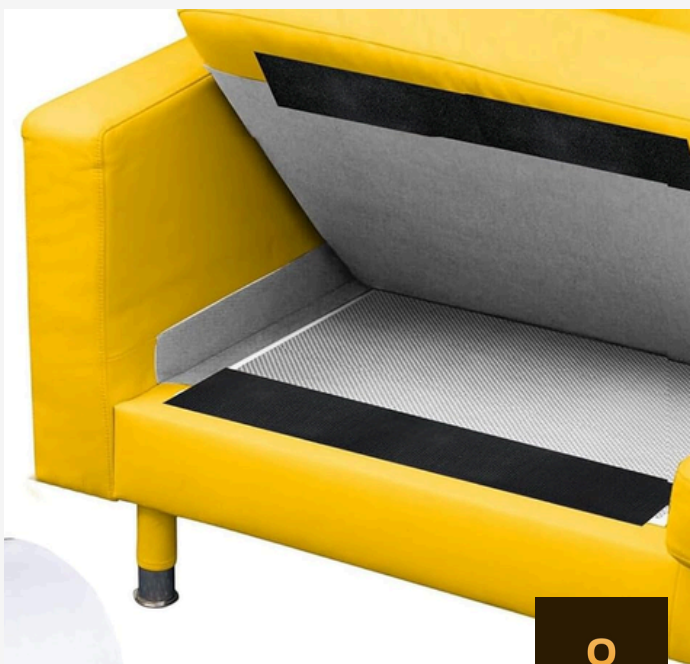

TAPICERIA

COLA DE RATA

CARACTERISTICAS:

Color: Blanco

Material: Plastico

5mm X 500 m

3mm X 1500 m



TAPICERIA

PATA PLASTICA

CARACTERISTICAS:

Plastica

Diametro: 33 mm

Alto: 13 mm

Color: Negro



TAPICERIA

NIVELADOR PLASTICA

CARACTERISTICAS:

Plastica

Diametro: 33 mm

Alto: 13 mm

Color: Blanco



1. Mark the suitable position on the furniture leg



2. Drill a hole with a diameter greater than 1in/2.54cm with an electric drill



3. Tap the nut with a hammer (Nut Not Included)



4. Screw the furniture leveler to the height you need

BALANCE YOUR LIFE!



TAPICERIA

AJUSTE DE ALCOBAS

CARACTERISTICAS:

Plastica

Diametro: 33 mm

Alto: 13 mm

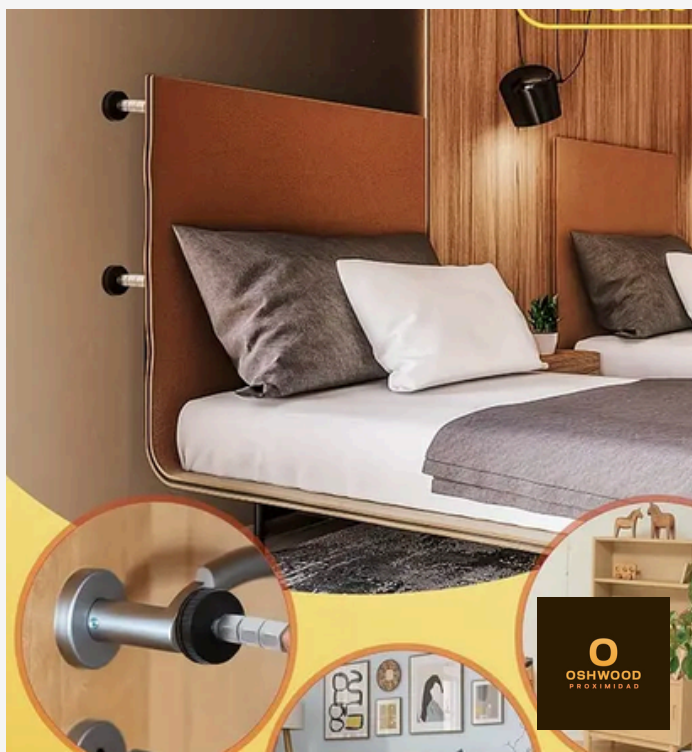
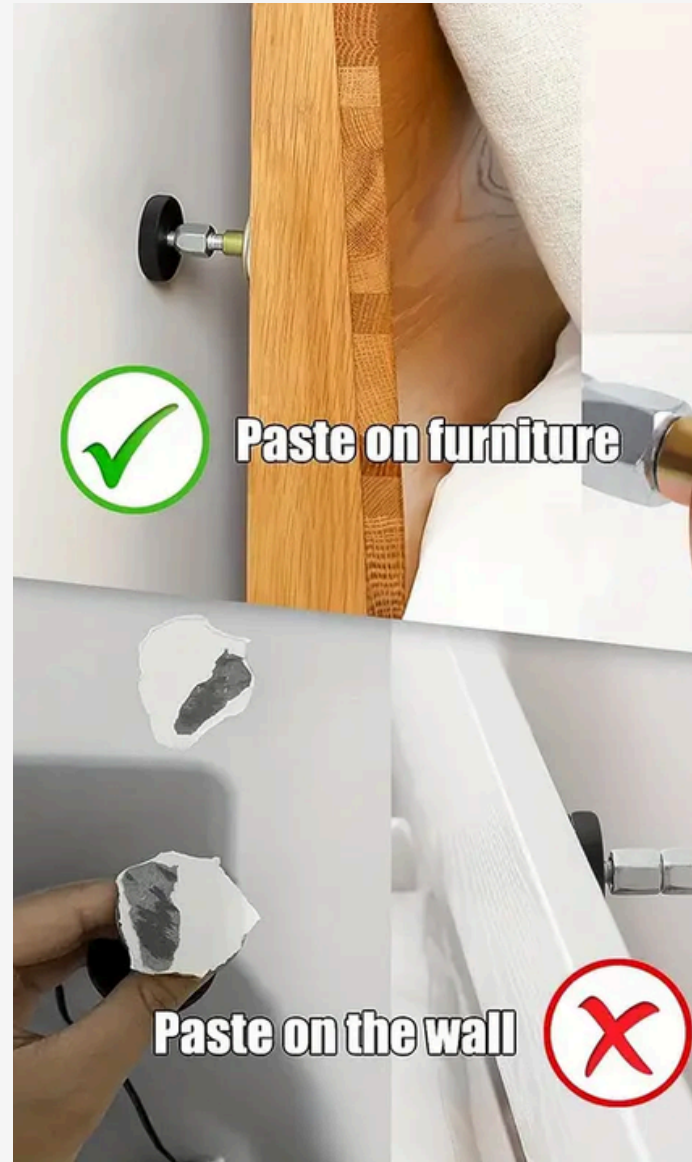

TAPICERIA

RIELES INVISIBLES

CARACTERISTICAS:
Montaje bajo
25 cm, 30 cm, 35 cm



HERRAJES

MECANISMO GIRATORIO

CARACTERISTICAS:

Tamaño del plato: 25X25

Tamaño total: 60 cm

Grosor del tubo: 1.2 mm



HERRAJES

MECANISMO CLICKCLACK

CARACTERISTICAS:

Largo: 26cm

Color: Negro

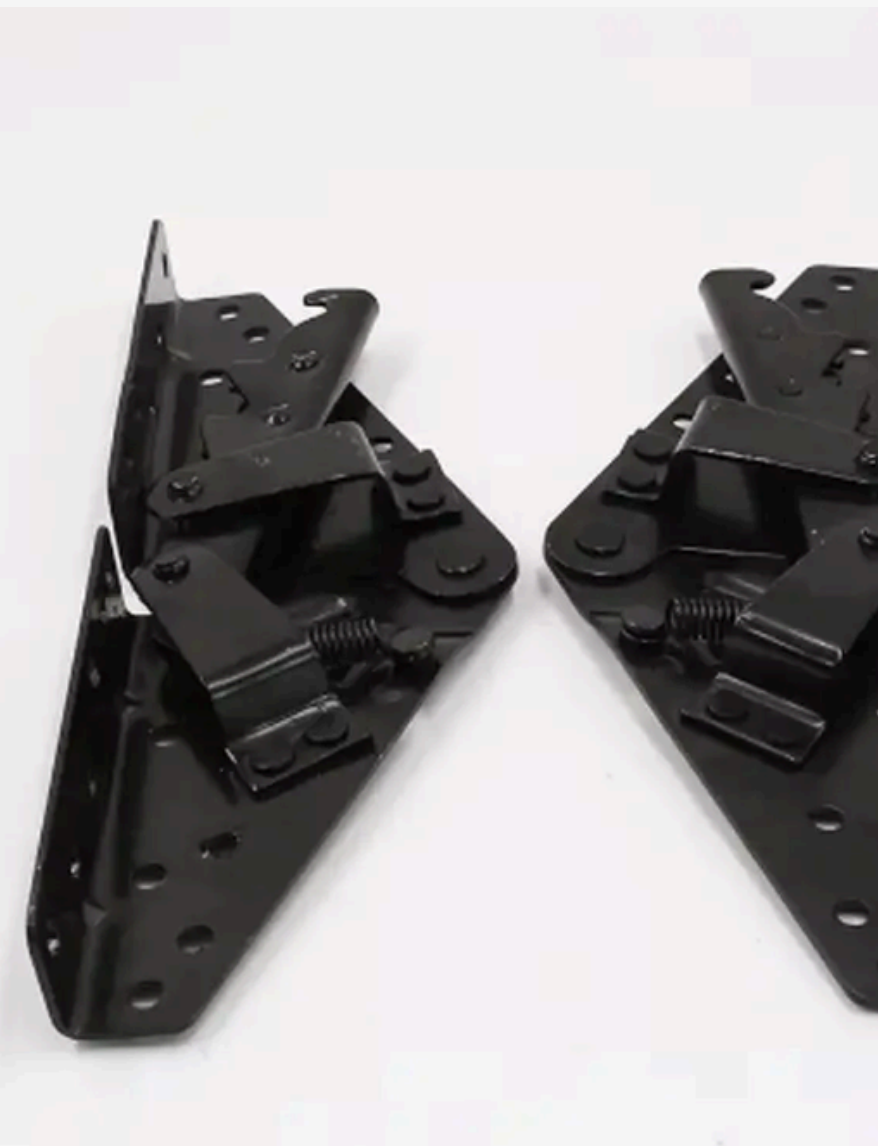

HERRAJES

MECANISMO C14

CARACTERISTICAS:

Ancho: 30 cm

Largo: 52 cm

Color: Negro

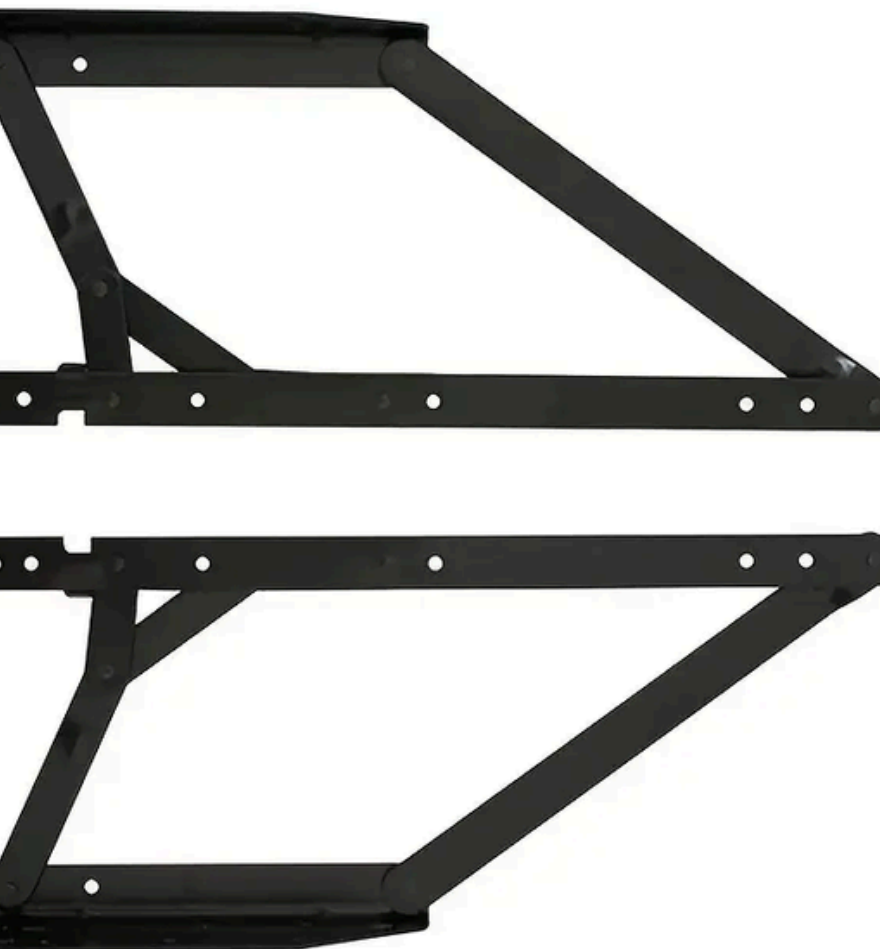

effect

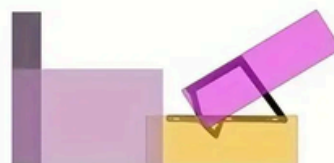

TAPICERIA

FIELTRO NEGRO

CARACTERISTICAS:

Ancho: 200 cm

Largo: 50 m

Peso: 20 Kg

Espesor: 1,2 mm



WIDE USE



TAPICERIA

TAFETA

CARACTERISTICAS:

Ancho: 150 cm

Largo: 100 m

Color: Negro, Gris

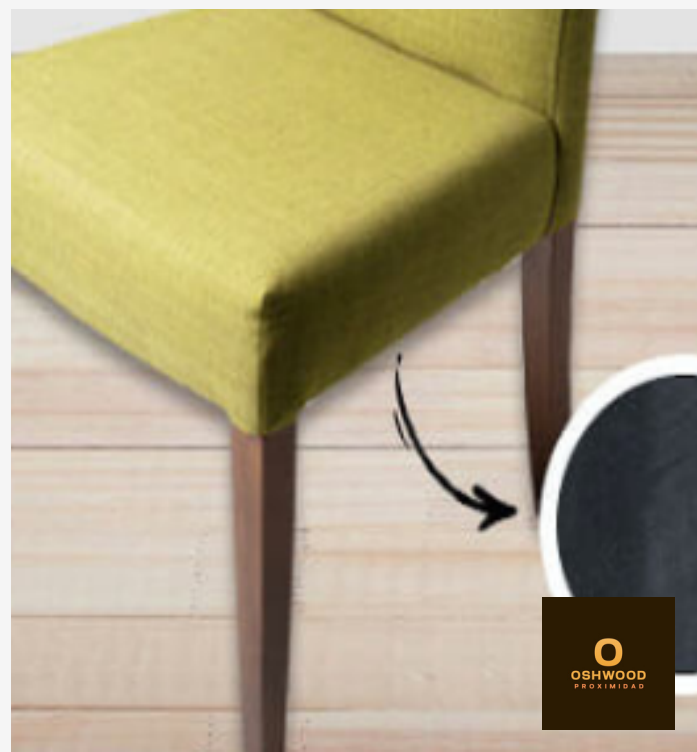

TAPICERIA

GUATA

CARACTERISTICAS:

Ancho: 300 cm

Largo: 50 m

Peso: 100 g



COMUNICATE CON NOSOTROS



+573001035901



@d.oshwood



Oshwood



FOSHWOOD